

alpha  
**chem**

Europe's largest producer  
of laundry tags, labels  
and  
numbered identification  
systems and cash-till rolls

imprint of  
individualised logo  
is possible here

Datum \_\_\_\_\_ 032 \*  
Name \_\_\_\_\_  
u. Adr. \_\_\_\_\_

Anzug	
Sakko	
Hose	
Kostüm	
Rock	
Kleid	
Mantel	
Pulli	

Mo Di Mi Do Fr Sa  
In diesem Betrag ist die gesetzliche MWSt. enthalten.

**Wir danken für Ihren Auftrag!**  
Es gelten die Lieferbedingungen lt. Ladenaushang.  
Rückgabe der Garderobe nur gegen diesen Beleg.

imprint of  
individualised logo  
is possible here

Datum \_\_\_\_\_ 032 \*  
Name \_\_\_\_\_  
u. Adr. \_\_\_\_\_

Anzug	
Sakko	
Hose	
Kostüm	
Rock	
Kleid	
Mantel	
Pulli	

Mo Di Mi Do Fr Sa  
In diesem Betrag ist die gesetzliche MWSt. enthalten.

032

032

032

032

## Kombi 2

Block à 2 x 50 pages

Page 1: Customer order confirmation

Page 2: Working card / invoice with 4 perforated labels on HYDROFIX®-Paper

Page 2 can be supplied

with punched hole of 8 mm Ø or drilled hole of 5 mm, 8 mm or 10 mm Ø



## Carbon paper

Blue carbon paper is available from stock  
(1 pack is sufficient for 200 blocks)



Datum \_\_\_\_\_ **3008** \*

Name: \_\_\_\_\_

<b>Anzug</b>	
<b>Sakko</b>	
<b>Hose</b>	
<b>Kostüm</b>	
<b>Rock</b>	
<b>Kleid</b>	
<b>Mantel</b>	
<b>Pulli</b>	

Mo Di Mi Do Fr Sa inkl. MWSt.

imprint of individualised logo is possible here

**Wir danken für Ihren Auftrag!**  
Es gelten die Lieferbedingungen lt. Ladenaushang.  
 Rückgabe der Garderobe nur gegen diesen Beleg.

Datum \_\_\_\_\_ **3000** \*

Name: \_\_\_\_\_

<b>Anzug</b>	
<b>Sakko</b>	
<b>Hose</b>	
<b>Kostüm</b>	
<b>Rock</b>	
<b>Kleid</b>	
<b>Mantel</b>	
<b>Pulli</b>	

Mo Di Mi Do Fr Sa inkl. MWSt.

imprint of individualised logo is possible here

<b>3000</b>	<b>3000</b>	<b>3000</b>	<b>3000</b>
-------------	-------------	-------------	-------------

# Kombi 2L

Block à 2 x 50 pages

Page 1: Customer order confirmation

Page 2: Working card / invoice with  
4 extra-long perforated labels on HYDROFIX®-Paper

Page 2 is supplied as standard with 8 mm Ø punched hole

imprint of  
individualised logo  
is possible here

Datum \_\_\_\_\_

Name **567 \* \***  
u. Adr. \_\_\_\_\_

**Mo Di Mi Do Fr Sa**  
In diesem Betrag ist die gesetzliche MWSt. enthalten.  
 m. Kn o. Kn m. Gü o. Gü m. Schn o. Schn  
 verschwitzt verfärbt versengt verschmutzt defekt Risiko Kunde

**Wir danken für Ihren Auftrag!**  
 Es gelten die Lieferbedingungen lt. Ladenaushang.  
 ☞ Rückgabe der Garderobe nur gegen diesen Beleg.

imprint of  
individualised logo  
is possible here

Datum \_\_\_\_\_

Name **567 \* \***  
u. Adr. \_\_\_\_\_

**Mo Di Mi Do Fr Sa**  
In diesem Betrag ist die gesetzliche MWSt. enthalten.  
 m. Kn o. Kn m. Gü o. Gü m. Schn o. Schn  
 verschwitzt verfärbt versengt verschmutzt defekt Risiko Kunde

<b>567</b>	<b>567</b>	<b>567</b>	<b>567</b>
------------	------------	------------	------------

## Kombi 3

Block à 2 x 50 pages

Page 1: Customer order confirmation

Page 2: Working card / invoice with

4 perforated labels on HYDROFIX®-Paper

Page 2 can be supplied

with punched hole of 8 mm Ø or

drilled hole of 5 mm, 8 mm or 10 mm Ø

**We use exclusively  
original  
HYDROFIX®-Paper**



imprint of individualised logo is possible here

**002 \***

Termin: \_\_\_\_\_

Preis: \_\_\_\_\_

**Anz Ja Ho Ko Ro Kl Bl Mtl Tch An Wo Bdr**  
Rückgabe nur bei Vorlage dieses Belegs. Lieferbedingungen siehe Aushang im Laden.

---

imprint of individualised logo is possible here

**002 \*** 

Termin: \_\_\_\_\_

Name: \_\_\_\_\_

Adresse: \_\_\_\_\_

	Anzug	
	Jacke	
	Hose	
	Kostüm	
	Rock - Plissee	
	Kleid - Gürtel - Plissee	
	Bluse - Weste	
	Mantel - Gürtel	
	Trench m. Imp. - Gürtel	
	Anorak m. Kap.	
	Strickjacke - Pullover	
	Binder	

K6A Kasse

Preis  
inkl. MWSt.

002  
\*

002  
\*

002  
\*

002  
\*

## Kombi 6A

Block à 50 pages  
 supplied as standard with  
 8 mm Ø punched hole

## for Dressmakers

imprint of individualised logo is possible here

Ma	Anz	Ja	Ho	He	We	Pu	T-Sh	Ga	Ko	Kl	Ro	Blu	
----	-----	----	----	----	----	----	------	----	----	----	----	-----	--

Preis: \_\_\_\_\_ €

**704 \***

Anz.: \_\_\_\_\_ €

Rückgabe nur gegen diesen Abholchein. Keine Haftung für Ware, die nicht binnen 3 Monaten abgeholt ist. Lieferbedingungen lt. Ladenaushang.

**Mo Di Mi Do Fr Sa**    **Mo Di Mi**    **Do Fr Sa**

**704 \*** 

Dat.: \_\_\_\_\_

Name: \_\_\_\_\_

Tel.: \_\_\_\_\_

He.-Mantel  
 Anzug  
 Jacke  
 Hose  
 Hemd

Weste  
 Pullover  
 T-Shirt  
 Gardinen  
 \_\_\_\_\_

Da.-Mantel  
 Kostüm  
 Kleid  
 Rock  
 Bluse



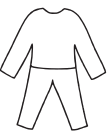



engen  
 kürzen  
 Reißverschluss  
 Kragen  
 Stoßband  
 Tasche  
 Futter

weiten  
 längen  
 kunststopfen  
 Gummiband  
 Saum nähen  
 Falte  
 Knöpfe / Knopfloch

vorne  
 hinten

K6A-S Anz.: \_\_\_\_\_ €

Preis: \_\_\_\_\_ €

704  
\*

704  
\*

704  
\*

704  
\*

## Kombi 6A-S

Block à 50 pages  
 supplied as standard with  
 8 mm Ø punched hole

imprint of individualised logo  
is possible here

Anz	Ja	Ho	Ko	Ro	Kl	Bl	Mtl	Tch	An	Wo	Bdr	He
-----	----	----	----	----	----	----	-----	-----	----	----	-----	----

Preis: \_\_\_\_\_

Termin: \_\_\_\_\_ **6035 \***

Rückgabe nur bei Vorlage dieses Belegs.  
Lieferbedingungen siehe Aushang im Laden.

---

Termin:  **6035 \***

Name: \_\_\_\_\_

Adresse: \_\_\_\_\_

Anzug	
Jacke	
Hose	
Kostüm	
Rock - Plissee	
Kleid - Gürtel - Plissee	
Bluse - Weste	
Mantel - Gürtel	
Trench m. Imp. - Gürtel	
Anorak m. Kap.	
Strickjacke - Pullover	
Binder	
Hemd	

alpha chem K6L Summe inkl. MWSt. \_\_\_\_\_

---

**6035 \*      6035 \***

---

**6035 \*      6035 \***

---

**6035 \*      6035 \***

---

**6035 \*      6035 \***

## Kombi 6L

Block à 50 pages, supplied as standard  
with 8 mm Ø punched hole

imprint of individualised logo  
is possible here

Anz	Ja	Ho	Ko	Ro	Kl	Bl	Mtl	Tch	An	Wo	He
-----	----	----	----	----	----	----	-----	-----	----	----	----

Preis: \_\_\_\_\_

Termin: \_\_\_\_\_ **1001 \***

Rückgabe nur bei Vorlage dieses Belegs. Lieferbedingungen siehe Aushang im Laden.

---

Dat.:  **1001 \***

Name: \_\_\_\_\_

Adresse: \_\_\_\_\_

Anzug	
Jacke	
Hose	
Kostüm	
Rock - Plissee	
Kleid - Gürtel - Plissee	
Bluse - Weste	
Mantel - Gürtel	
Trench m. Imp. - Gürtel	
Anorak m. Kap.	
Strickjacke - Pullover	
Hemd	

alpha chem K25

---

**1001 \***

---

**\* 1001**

---

**1001 \***

---

**\* 1001**

---

**1001 \***

---

**\* 1001**

---

**1001 \***

## Kombi 25

Block à 50 pages  
with 2 normal and 5 narrow tags

**All images  
in original size !**

imprint of individualised logo  
is possible here

\_\_\_\_\_ Teile                      **001 \*  
\_\_\_\_\_ €**

**HINWEIS!**  
Es gelten unsere Lieferungsbedingungen lt. Aushang.  
Rückgabe der Garderobe nur gegen diesen Beleg.

TAG:	Mo	Di	Mi	Do	Fr	Sa					
STUNDE:	9	10	11	12	13	14	15	16	17	18	19

TAG: \_\_\_\_\_  
STUNDE: \_\_\_\_\_

○                      **001 \***

Name: \_\_\_\_\_

Trench	H	D	K
Sakko			
Hose			
Kostümjacke			
Rock			
Kleid			
Mantel			
Pulli	Weste	Bluse	

alpha chem K7

**001 \*    001 \*    001 \*    001 \***

## Kombi 7

Block à 50 pages  
supplied as standard with  
8 mm Ø punched hole

imprint of individualised logo  
is possible here

Teile: \_\_\_\_\_  
Preis: \_\_\_\_\_                      **0253 \*  
HINWEIS!**  
Es gelten unsere Lieferungs-  
bedingungen, siehe Aushang.

Teile: \_\_\_\_\_ ○                      **0253 \*  
Preis: \_\_\_\_\_**

9 10 11 12 13  
14 15 16 17 18                      ○                      **0253 \***

Name: \_\_\_\_\_

Anzug	Kostüm
Sakko	Jacke
Hose	
Rock	
Kleid	
Mantel	
Pulli	Weste
Bluse	

alpha chem K7A

**0253 \*    0253 \*    0253 \*    0253 \***

## Kombi 7A

Block à 50 pages  
supplied as standard with  
8 mm Ø punched hole on 2. and 3. part



**All forms are available in your language**

imprint of individualised logo  
is possible here

Preis: \_\_\_\_\_ € **5007 \***

Rückgabe nur bei Vorlage dieses Belegs.  
Lieferbedingungen siehe Aushang im Laden.

Ho	Ro	Sa	Ja	Kl	Ma	Pu	We	Bl	
----	----	----	----	----	----	----	----	----	--

TAG: Mo Di Mi Do Fr Sa  
STUNDE: 9 10 11 12 13 14 15 16 17 18

TAG: Mo Di Mi Do Fr Sa  
STUNDE: 9 10 11 12 13 14 15 16 17 18

Datum: ○ **5007 \***

Name:

Hose	H D K	
Rock		
Sakko / Jacke		
Kleid		
Mantel – Popeline		
Pulli	Weste	
Bluse		

alpha chem K7L Summe inkl. MWSt.

<b>5007 *</b>	<b>5007 *</b>	<b>5007 *</b>	<b>5007 *</b>
---------------	---------------	---------------	---------------

## Kombi 7L

Block à 50 pages  
supplied as standard  
with 8 mm Ø punched hole



imprint of individualised logo  
is possible here

Preis: \_\_\_\_\_ € **7401 \***

Rückgabe nur bei Vorlage dieses Belegs.  
Lieferbedingungen siehe Aushang im Laden.

Az	Kos	Ho	Ro	Ja	Ma	PopMa	Kl	Pu	Bl	
----	-----	----	----	----	----	-------	----	----	----	--

TAG: Mo Di Mi Do Fr Sa  
STUNDE: 8 9 10 11 12 13 14 15 16 17 18 19

TAG: Mo Di Mi Do Fr Sa  
STUNDE: 8 9 10 11 12 13 14 15 16 17 18 19

Datum: ○ **7401 \***

Name:

Anzug / Kostüm	
Hose	
Rock	
Jackett	
Mantel	
Popeline-Mantel	
Kleid	
Pullover / Pulli	
Bluse	

alpha chem K7M Preis (incl. MWSt) €

<b>7401 *</b>	<b>7401 *</b>	<b>7401 *</b>	<b>7401 *</b>
<b>7401 *</b>	<b>7401 *</b>	<b>7401 *</b>	<b>7401 *</b>

## Kombi 7M

Block à 50 pages  
supplied as standard with 8 mm Ø  
punched hole



imprint of individualised logo  
is possible here

**7506 \***

Ihr Kleidungsstück wird zu den im Geschäft aushängenden Lieferbedingungen bearbeitet. Für Knöpfe, Polster, Reißverschlüsse, Schnallen, Lederbesatz keine Haftung.

Anzug	Hose	Sakko	
Kostüm	Rock	Jacke	
Mantel	Anorak	Bluse	
Kleid	Kraw.	Pulli	
Decke	Vorhänge		
			€

K 8 A

Name:

Anzug	Hose	Sakko	
Kostüm	Rock	Jacke	
Mantel	Anorak	Bluse	
Kleid	Kraw.	Pulli	
Decke	Vorhänge		
			€

**7506 \***

<b>7506</b>	<b>7506</b>	<b>7506</b>	<b>7506</b>
-------------	-------------	-------------	-------------

## Kombi 8A

Block à 50 pages

We use exclusively  
original  
**HYDROFIX®-Paper**



All forms are available in your language

imprint of individualised logo  
is possible here

**0004 \***

Rückgabe nur gegen Vorlage dieses Beleges. Auftragsbestätigung u. Vor-  
kasse-Quittung einschließlich MWSt.-  
Lieferbedingungen siehe Aushang im  
Laden.

Teile \_\_\_\_\_  
Preis \_\_\_\_\_

---

**0004 \***

○

	<b>Hose</b>		Mo	Di
	<b>Rock</b>		Mi	Do
	<b>Jacke</b>		Fr	Sa
	<b>Kleid</b>		9	10
	<b>Mantel</b>		11	12
	<b>Pullover</b>		13	14
	<b>Hemd</b>		15	16
			17	18
			19	20

**alphax**  
chem K11

---

**0004 \***

---

**\* 7000**

---

**0004 \***

---

**\* 7000**

## Kombi 11

Block à 50 pages  
supplied as standard with 8 mm Ø punched hole

imprint of individualised logo  
is possible here

**002 \***

Rückgabe nur bei Vorlage dieses Belegs. Lieferbedingungen s. Aushang im Laden.

An	Sa	Ho	Kl	Pu	Bl	
Ko	Ja	Ro	Ma	We	Preis:	

Mo Di Mi Do Fr Sa  
Mo Di Mi Do Fr Sa

Datum: \_\_\_\_\_

**002 \***

Name: \_\_\_\_\_

Anzug	Kostüm	
Sakko	Jacke	
Hose	Rock	
Kleid		
Mantel		
Pulli	Weste	
Bluse		

**alphax**  
chem K20

---

**002 \***

---

**002 \***

---

**002 \***

## Kombi 20

Block à 50 pages



All forms are available in your language

		1055 * <span style="margin-left: 20px;">○</span> imprint of individualised logo is possible here			
		Name			
		Adresse			
1055 * <span style="margin-left: 20px;">○</span>		Anzug / Kostüm			
		Hose			
		Rock			
		Jackett			
		Mantel			
		Kleid			
		Pullover			
Name		Datum: TOTAL			
Adresse		◆ ALPHA-CHEM-Auszeichnung „Ki,neu“			
Anzug / Kos		imprint of individualised logo is possible here  <b>1055 * Bitte beachten!</b>  Diesen Auftragszettel aufbewahren und bitte vorlegen, wenn Sie Ihren Auftrag abholen. Für Garderobe, die nicht innerhalb von 30 Tagen abgeholt ist, wird keine Haftung übernommen. Mit Auftragserteilung werden die im Laden aushängenden Lieferbedingungen anerkannt.			
Hose					
Rock					
Jackett					
Mantel					
Kleid					
Pullover					
Datum:					
◆ ALPHA-CHEM-Auszeichnung					
1055 *	1055 *	<table border="1" style="width: 100%;"> <tr> <td style="width: 50%;"><b>Abholzeit:</b></td> <td style="width: 50%;"><b>Preis</b></td> </tr> </table>		<b>Abholzeit:</b>	<b>Preis</b>
<b>Abholzeit:</b>	<b>Preis</b>				
1055 *	1055 *	1055 *	1055 *		

**„Ki - neu“**

2 x 50 pages

page 1: collection receipt and branch / chain store ticket

page 2: working ticket / invoice with 8 perforated labels

Standard with 5 mm Ø punched hole for all pages

# pre-printed cash register booklets

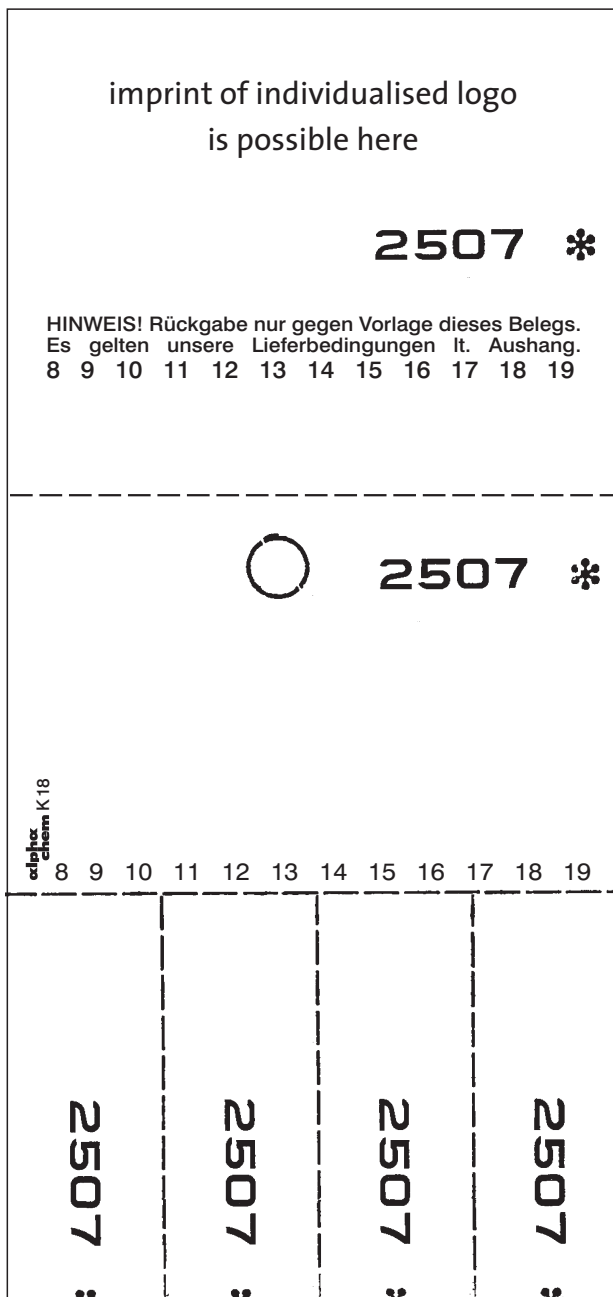

## Kombi 18

Block à 50 pages  
supplied as standard with 8 mm Ø punched hole

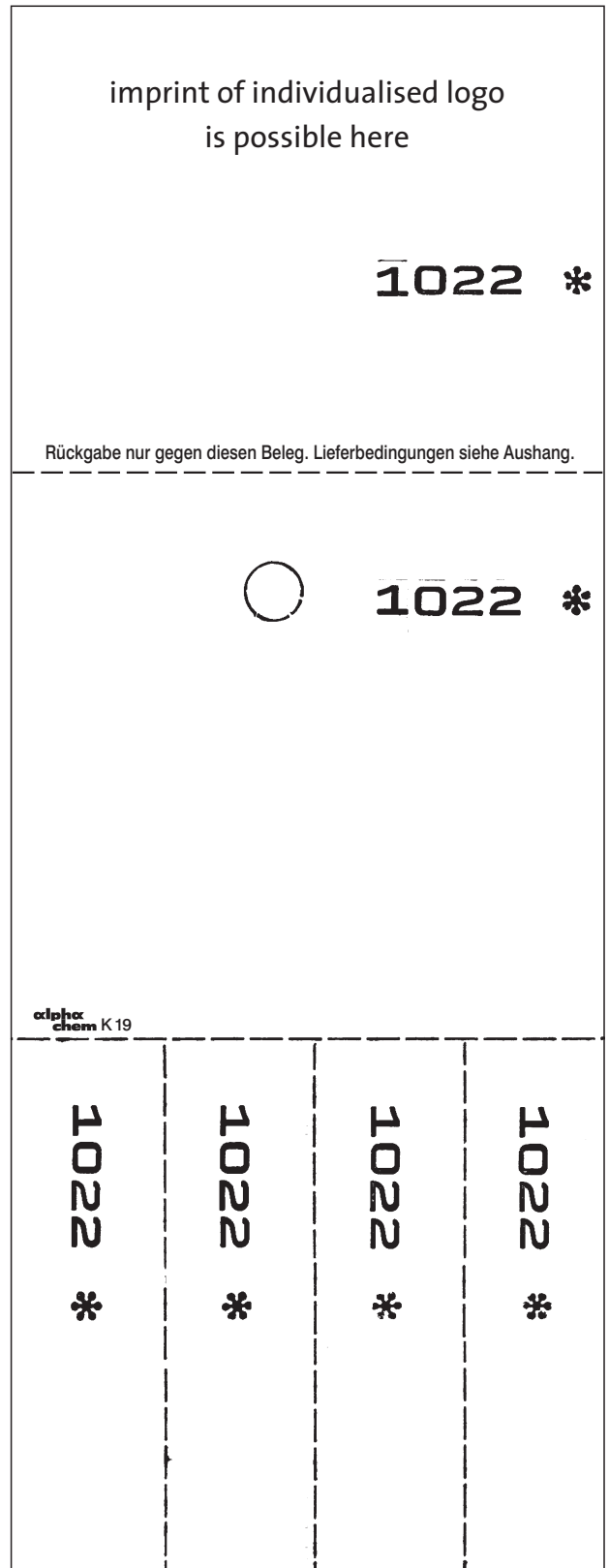

## Kombi 19

Block à 50 pages, supplied as standard  
with 8 mm Ø punched hole

imprint of individualised logo  
is possible here

**493 \***

Mit Auftragserteilung werden  
die im Laden aushängenden  
Lieferbedingungen anerkannt.

8 9 10 11 12 13 14 15 16 17 18 19

**Betrag:**

---

8 9 10 11 12 13 14 15 16 17 18 19

○ **493 \***

alphax  
chem K70

<b>493 *</b>	<b>493 *</b>	<b>493 *</b>	<b>493 *</b>
--------------	--------------	--------------	--------------

## Kombi 70

Block à 50 pages  
supplied as standard  
with 8 mm Ø punched hole

imprint of individualised logo  
is possible here

**993 \***

HINWEIS! Rückgabe nur gegen Vorlage dieses Belegs.  
Es gelten unsere Lieferbedingungen lt. Aushang.

8 9 10 11 12 13 14 15 16 17 18

---

	Ho	○	<b>993 *</b>
	Ro		
	Pu		
	KI/Ja		
	Bl		
	An		
	P.-Ma		
	Ma		
	T		

alphax  
chem K7 SVP

9 10 11 12 13 14 15 17 18

<b>993 *</b>	<b>993 *</b>	<b>993 *</b>	<b>993 *</b>
--------------	--------------	--------------	--------------

## Kombi 7 SVP

Block à 50 pages  
supplied as standard  
with 8 mm Ø punched hole



All forms are available in your language

# stain marks

Block à 500 pages

Paper: 60 gsm (yellow)

Um dieses Kleidungsstück haben wir uns besonders bemüht.  
Dennoch sind die verbliebenen

## **Flecken**

nicht besser zu entfernen,  
ohne Stoff und Farben anzugreifen.



*Chemisch gereinigt  
nach den neuesten  
Erkenntnissen von Forschung  
und Technik*

(gemäß RAL 990 A2)



- Die in diesem Teil noch vorhandenen Verfleckungen lassen sich ohne Gefahr für Gewebe und/oder Farben nicht besser entfernen
- Besserer Ausfall nicht zu erreichen
- Nachbehandlung auf Gefahr des Kunden möglich
- Verfärbung
- Farbverlust
- Brandschaden
- Nicht reinigungsbeständige Verklebung
- Abgetragenen Scheuerstelle
- Gewebebeschädigungen

## **stain marks, pink or orange**

unglued, 1 unit = 1000 sheets  
supplied as standard  
with 5 mm Ø drilled hole  
Paper: 120 gsm



**All images  
in original size !**



We use exclusively  
original  
HYDROFIX®-Paper

### Individual Identification Blocks

1 pack= 10 blocks = 5000 single tags  
with branch number

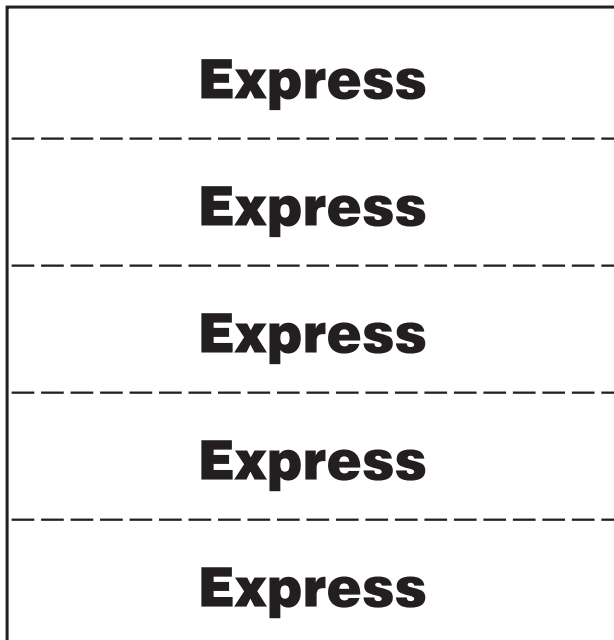
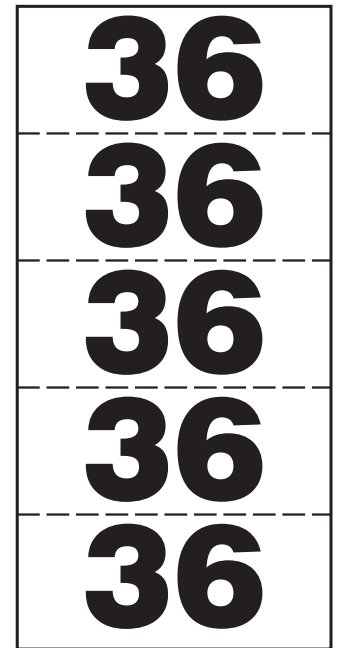

### Markingtags

1 Block à 100 pages = 500 tags  
1 pack = 10 Blocks



All forms are available in your language

Rückgabe nur gegen Vorlage dieses Belegs. Lieferbedingungen: Siehe Aushang!

**0504 \***  Hemden Preis (incl. MWST.)

**Auftrag**  auf Bügel  gelegt  nur bügeln

imprint of individualised logo  
is possible here

---

**Rechnung** **0504 \***

Datum    Hemden Preis (incl. MWST.)

auf Bügel  gelegt  nur bügeln

Name

Adresse  alphax  
chem  
OHD

---

**0504 \***

---

**\* 7090**

---

**0504 \***

---

**\* 7090**

---

**0504 \***

## OHD, 5 tags

Block à 50 pages

Rückgabe nur gegen Vorlage dieses Belegs. Lieferbedingungen: Siehe Aushang!

**0504 \***  Hemden Preis (incl. MWST.)

**Auftrag**  auf Bügel  gelegt  nur bügeln

imprint of individualised logo  
is possible here

---

**Rechnung** **0504 \***

Datum    Hemden Preis (incl. MWST.)

auf Bügel  gelegt  nur bügeln

Name

Adresse  alphax  
chem  
OHD

---

**0504 \***

---

**\* 7090**

---

**0504 \***

---

**\* 7090**

---

**0504 \***

---

**\* 7090**

---

**0504 \***

---

**\* 7090**

---

**0504 \***

---

**\* 7090**

## OHD, 10 tags

Block à 50 pages



All forms are available in your language



<b>alpha chem</b> marking-system	KLS

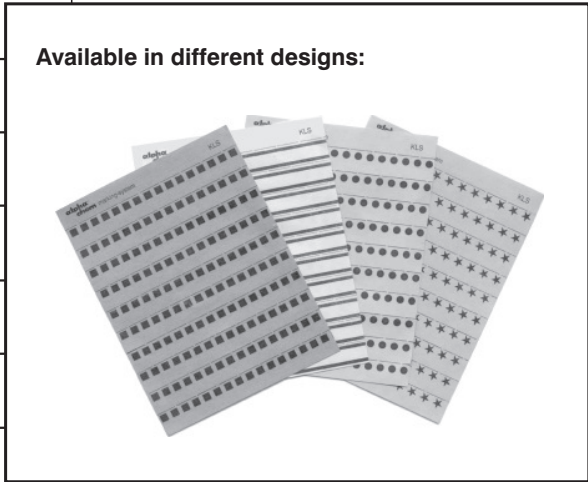

**KLS** (without numbering),  
1 series = 10 blocks à 100 pages

350 * 0
350 * 0
350 * 4
350 * 0
350 * 3
350 * 0
350 * 2
350 * 0
350 * 1
350 * 0
350 *

### Quickmarker

1 series = 20 blocks =  
numb. 1-1000

<b>alpha chem</b> marking-system	HAS
0110 *	
* 6010	
0108 *	
* 7010	
0106 *	
* 8010	
0104 *	
* 9010	
0102 *	
* 1010	

### HAS

1 series = 10 blocks à 100 pages  
(numb. 1-10.000)

alpha chem marking-system		
1690 *	1690 *	1690 *
1689 *	1689 *	1689 *
1688 *	1688 *	1688 *
1687 *	1687 *	1687 *
1686 *	1686 *	1686 *
1685 *	1685 *	1685 *
1684 *	1684 *	1684 *
1683 *	1683 *	1683 *
1682 *	1682 *	1682 *
1681 *	1681 *	1681 *

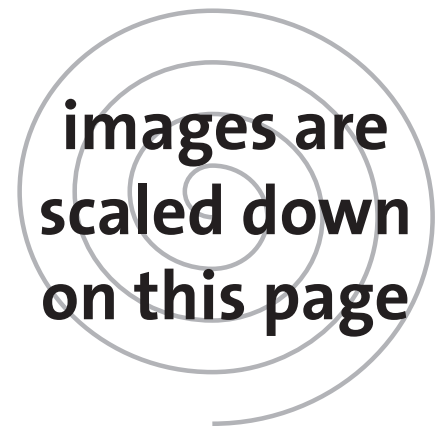

## Number blocks

Single-numbered,  
double-numbered,  
triple-numbered

1 pack = 10 blocks =  
numbered 1-10.000,  
resp. 2x 1-10.000  
and 3x 1-10.000

alpha chem marking-system	
1690 *	1690 *
1689 *	1689 *
1688 *	1688 *
1687 *	1687 *
1686 *	1686 *
1685 *	1685 *
1684 *	1684 *
1683 *	1683 *
1682 *	1682 *
1681 *	1681 *

alpha chem marking-system
1690 *
1689 *
1688 *
1687 *
1686 *
1685 *
1684 *
1683 *
1682 *
1681 *



# Barcode Forms

Digitalisation has long since established itself in all areas of dry-cleaning and laundry services. For safe and reliable registration of orders we are able to supply the following standard printed barcode forms:

K6L, K7, K7o, K7SVP, W22 and HAS

Depending on the system used within your company or organization, we offer, dependent on the print from chosen, various barcode types, for example EAN 8, EAN 13, 2D, Interleaved 2 of 5 or Code 128.

According to the code-type selected, modifications to the printed form can be made to take into consideration subdivisions for filial, delivery-route, branch-office, and sequential numbering, and other options.

*imprint of individualised logo  
is possible here*

\_\_\_\_\_ Teile   
 \_\_\_\_\_ € 0 0 5 0 2 5

**HINWEIS!**  
 Es gelten unsere Lieferungsbedingungen lt. Aushang.  
 Rückgabe der Garderobe nur gegen diesen Beleg.

TAG:	Mo	Di	Mi	Do	Fr	Sa					
STUNDE:	9	10	11	12	13	14	15	16	17	18	19

TAG:	Mo	Di	Mi	Do	Fr	Sa					
STUNDE:	9	10	11	12	13	14	15	16	17	18	19

C128   
 0 0 5 0 2 5

**Name:**

Trench	H	D	K
Sakko			
Hose			
Kostümjacke			
Rock			
Kleid			
Mantel			
Pulli	Weste	Bluse	

ediplex  
chem K7

0 0 5 0 2 5	0 0 5 0 2 5	0 0 5 0 2 5	0 0 5 0 2 5
-------------	-------------	-------------	-------------

sample: K7 Barcode type C128



All forms are available in your language

# Till rolls

## Hydrofix Till rolls

80 gsm, available in 11 colours

(120 gsm and 190 gsm are available in selected rolls sizes and colours)

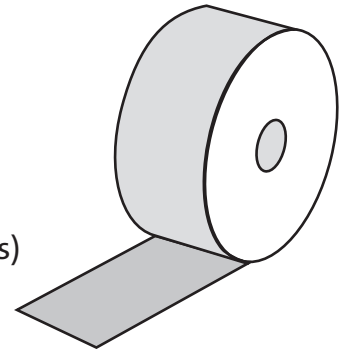

### width:

**38 mm** 17,5 mm core, 41 m Length, Diameter 80 mm max.

**44 mm** 17,5 mm core, 41 m Length, Diameter 80 mm max.

**70 mm** 17,5 mm core, 31 m Length, Diameter 70 mm max.  
please ask for available colours

**76 mm** 12 mm core, 42,3 m Length, Diameter 80 mm max.

**76 mm** 17,5 mm core, 33 m Length, Diameter 70 mm

**57 mm** 17,5 mm core, Diameter 70 mm  
please ask for available colours

120 gsm

**76 mm** 17,5 mm core, Diameter 80 mm

**Thermo-Rolls, with a unique  
and identifiable colour design,  
for dry-cleaner and laundry counter  
and cash-till printers**

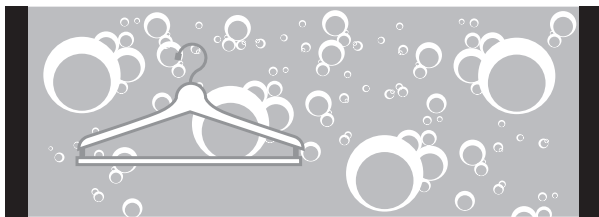

Width 80 mm , Diameter 80 mm,  
12 mm core

**Available in following colours:  
red, purple, yellow, orange, blue, light-green**

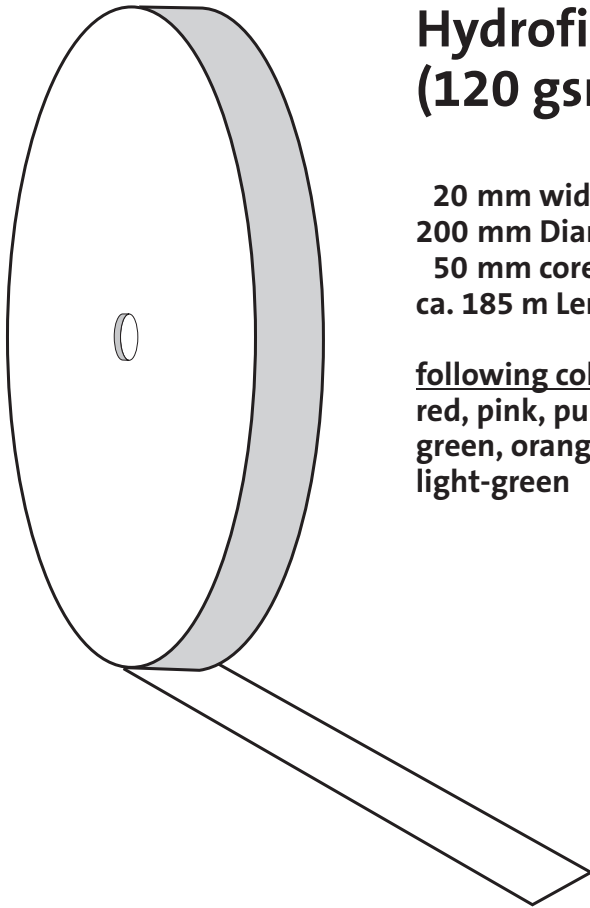

## Hydrofix rolls 20/200 (120 gsm)

20 mm width  
200 mm Diameter  
50 mm core  
ca. 185 m Length

following colours are available:  
red, pink, purple, yellow, brown,  
green, orange, blue, white,  
light-green

HYDROFIX® 120 g/m <sup>2</sup>	
waschfestes Papier Laundry Tag Paper carta lavabile papier lavable	
alpha chem	
www.alpha-chem.de / www.alpha-chem.com info@alpha-chem.de	
11	light-green hell-grün
10	white weiß
9	blue blau
8	orange
7	green grün
6	brown braun
5	yellow gelb
4	violet lila
3	pink rosa
2	red rot
1	grey grau

**Material: Hydrofix 120 gsm**

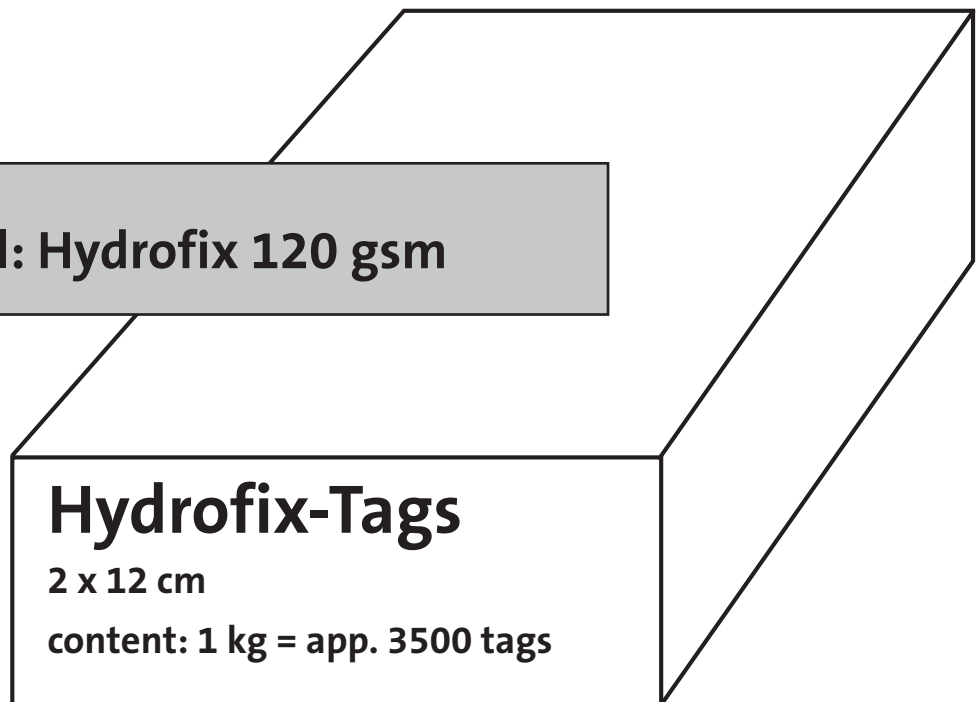

### Hydrofix-Tags

2 x 12 cm

content: 1 kg = app. 3500 tags